



25W Single Output AC Dimmable LED Power Supply

PCD-25 series



■ Features :

- AC phase-cut dimming
- Work with leading edge and trailing edge TRIAC dimmers
- 115VAC or 230VAC models available
- Built-in active PFC function
- Constant current design
- Protections: Short circuit / Over temperature
- Cooling by free air convection
- Fully isolated plastic case
- IP30 design
- Class II power unit, no FG
- Class 2 power unit
- Suitable for indoor LED lighting applications
- 100% full load burn-in test
- Low cost
- High reliability
- 3 years warranty



PCD-25-350 A : With AC input 90~ 135VAC.
 B : With AC input 180 ~ 295VAC.

SPECIFICATION

MODEL	PCD-25-350 <input type="checkbox"/>	PCD-25-700 <input type="checkbox"/>	PCD-25-1050 <input type="checkbox"/>	PCD-25-1400 <input type="checkbox"/>	
OUTPUT	RATED CURRENT	350mA	700mA	1050mA	1400mA
	OPERATING VOLTAGE RANGE	40 ~ 58V	24 ~ 36V	16 ~ 24V	12 ~ 18V
	CURRENT ACCURACY	±5.0%			
	RATED POWER	20.3W	25.2W	25.2W	25.2W
	RIPPLE & NOISE (max.) Note.1	4.6Vp-p	2.7Vp-p	2.2Vp-p	2Vp-p
	NO LOAD OUTPUT VOLTAGE (max.)	63V	50V	35V	25V
SETUP TIME	1000ms / 230VAC 2000ms / 115VAC at full load				
INPUT	FREQUENCY RANGE	47 ~ 63Hz			
	POWER FACTOR (Typ.)	PF>0.9/115VAC, PF>0.9/230VAC, PF>0.9/277VAC at full load (Please refer to "Power Factor Characteristic" curve)			
	EFFICIENCY (Typ.)	82%	81%	80.5%	80%
	AC CURRENT (Typ.)	0.6A/115VAC	0.3A/230VAC	0.2A/277VAC	
	INRUSH CURRENT(max.)	COLD START 10A(twidth=20μs measured at 50% I _{peak}) at 115VAC / 230VAC			
LEAKAGE CURRENT	<0.5mA 120VAC / 240VAC				
PROTECTION	SHORT CIRCUIT	Hiccup mode, recovers automatically after fault condition is removed.			
	OVER TEMPERATURE	95°C ±10°C (RTH1) Protection type : Shut down o/p voltage, re-power on to recover			
ENVIRONMENT	WORKING TEMP.	-30 ~ +60°C (Refer to "Derating Curve")			
	WORKING HUMIDITY	20 ~ 95% RH non-condensing			
	STORAGE TEMP., HUMIDITY	-40 ~ +80°C, 10 ~ 95% RH			
	TEMP. COEFFICIENT	±0.03%/°C (0 ~ 50°C)			
VIBRATION	10 ~ 500Hz, 2G 12min./1cycle, period for 72min. each along X, Y, Z axes				
SAFETY & EMC	SAFETY STANDARDS	UL8750, CSA C22.2 No. 250.0-08(except for PCD-25-350, PCD-25-700), ENEC EN613471, EN61347-2-13, EN62384(for B type only), IP30 approved ; design refer to UL60950-1, TUV EN60950-1, EN61347-1, EN61347-2-13			
	WITHSTAND VOLTAGE	I/P-O/P:3.75KVAC			
	ISOLATION RESISTANCE	I/P-O/P:100M Ohms / 500VDC / 25°C / 70% RH			
	EMC EMISSION	Compliance to EN55015 (B type only), EN61000-3-2 Class C ; EN61000-3-3, FCC part 18 non-consumer equipment (A type only)			
EMC IMMUNITY	Compliance to EN61000-4-2,3,4,5,6,8,11, EN55024,EN61547, light industry level, criteria A				
OTHERS	MTBF	906.5K hrs min. MIL-HDBK-217F (25°C)			
	DIMENSION	84*57*29.5mm (L*W*H)			
	PACKING	0.19Kg; 72pcs/14.7Kg/0.92CUFT			
NOTE	1. Ripple & noise are measured at 20MHz of bandwidth by using a 12" twisted pair-wire terminated with a 0.1uf & 47uf parallel capacitor. 2. Direct connecting to LEDs is suggested, but is not suitable for using additional drivers.				

Mechanical Specification

Case No.PCD16A Unit:mm

A Type:(PCD-25-A)

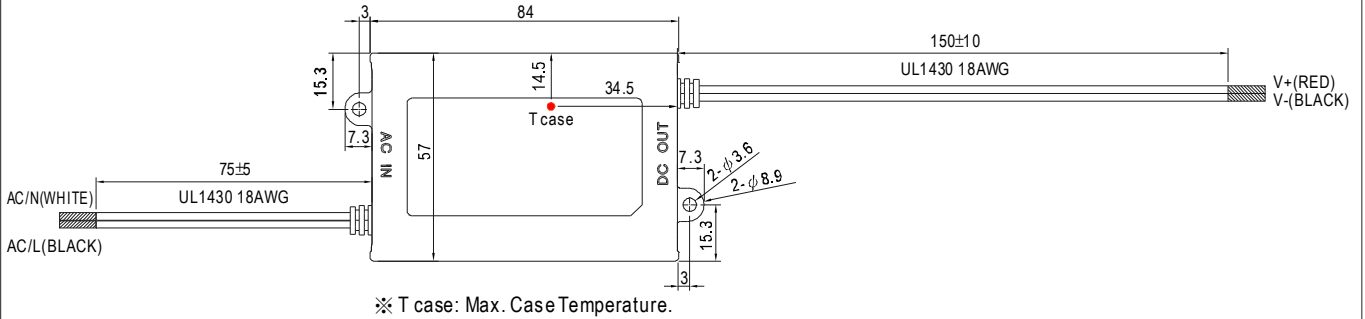

B Type:(PCD-25-B)

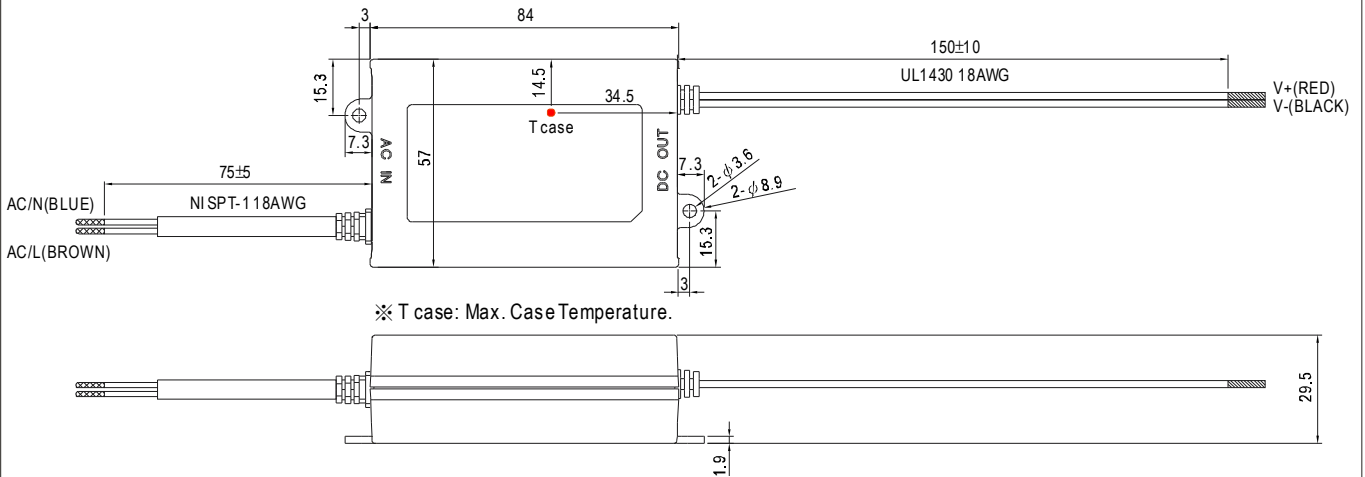

Block Diagram

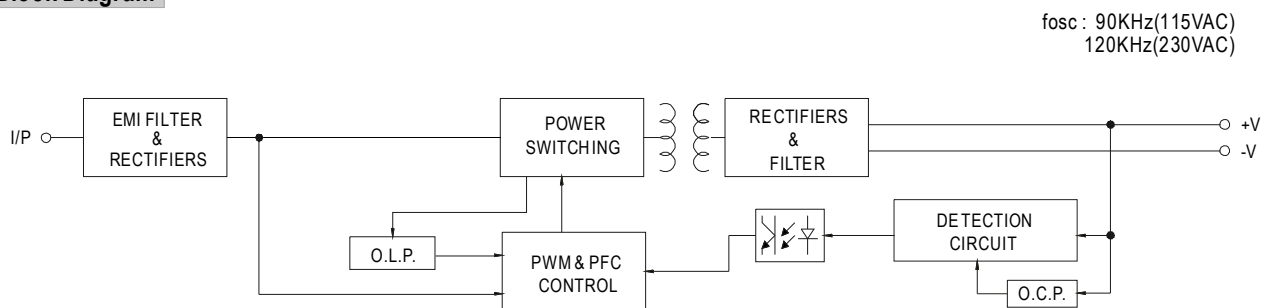

■ Derating Curve

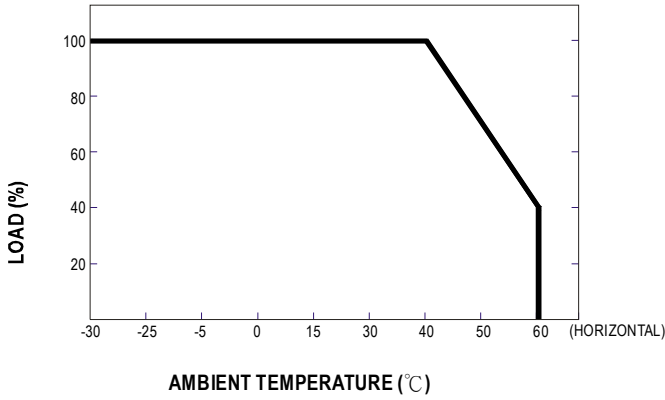

■ Static Characteristics

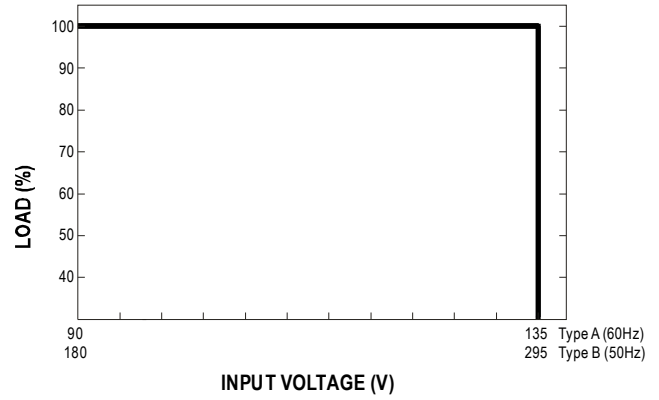

■ Power Factor Characteristic

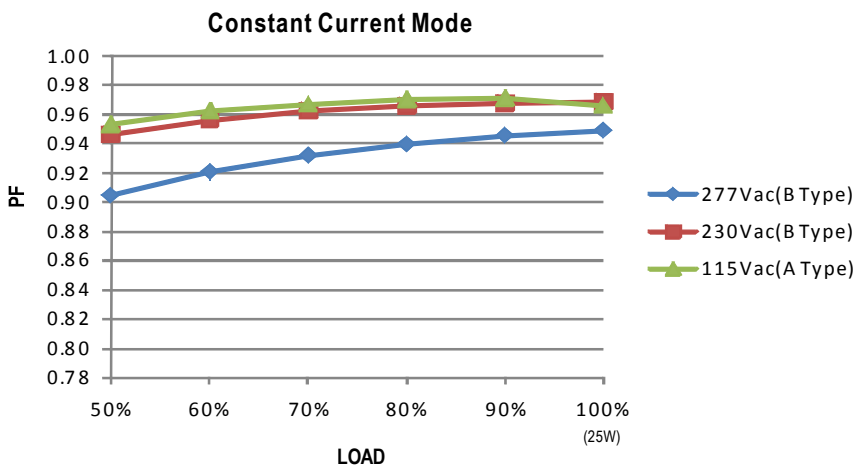

■ EFFICIENCY vs LOAD (PCD-25-350)

PCD-25 series possess superior working efficiency that up to 86% can be reached in field applications.

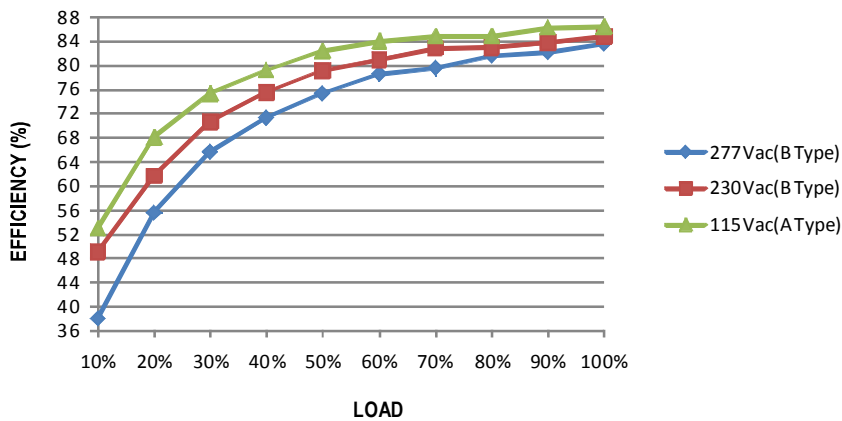

AC Dimming Operation

⊙ The following diagram depicts a typical installation utilizing the PCD-25 :

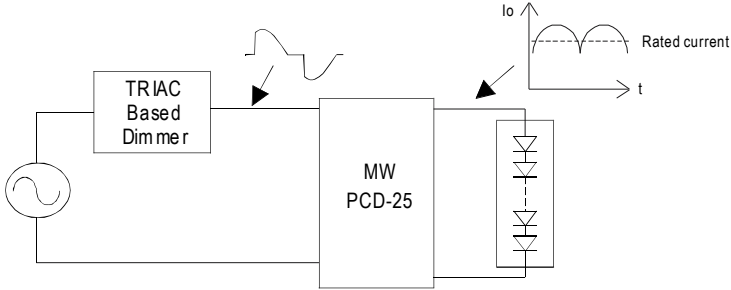

Under direct driving, the powersupply will work in "constant current mode (CC)" and output voltage of the power supply will be clamped by sum of forward voltage (V_f) of the LED strip.

⊙ Dimmer Compatibility Chart

Manufacturer	Dimmer Model	
LUTRON	SKY LAR K SF- 12P-277	(277VAC / 60Hz)
LUTRON	DVF-103P-277	(277VAC / 60Hz)
LUTRON	SKY LAR K SF- 10P	(120VAC / 60Hz)
LUTRON	SKY LAR K S-600P	(120VAC / 60Hz)
LUTRON	SKY LAR K DVF-103P	(120VAC / 60Hz)
LEVITON	ILLUMATECH™ Cat.No. IP 106	(120VAC / 60Hz)
LEVITON	SURESLIDE™ Cat.No.6633-P	(120VAC / 60Hz)
LEVITON	SURESLIDE™ Cat. NO.6615-P	(120VAC / 60Hz)
JUNG	Licht-Management 225 TDE	(230VAC / 50Hz)
JUNG	Licht-Management 225 NV DE	(230VAC / 50Hz)
BERKER	Tronic-Drehdimmer 2867 10	(230-240VAC / 50Hz)
Bodo Ehmann LICHTREGLER	T39.01	(230VAC / 50Hz)
CLIPSAL	32E450UDM	(220-240VAC / 50Hz)
CLIPSAL	NO 32E450TM	(220-240VAC / 50Hz)

Conduction angle: 30 degrees(min.) / 180 degrees(max.)